

# **RSIC-SI-1 ULTRA**

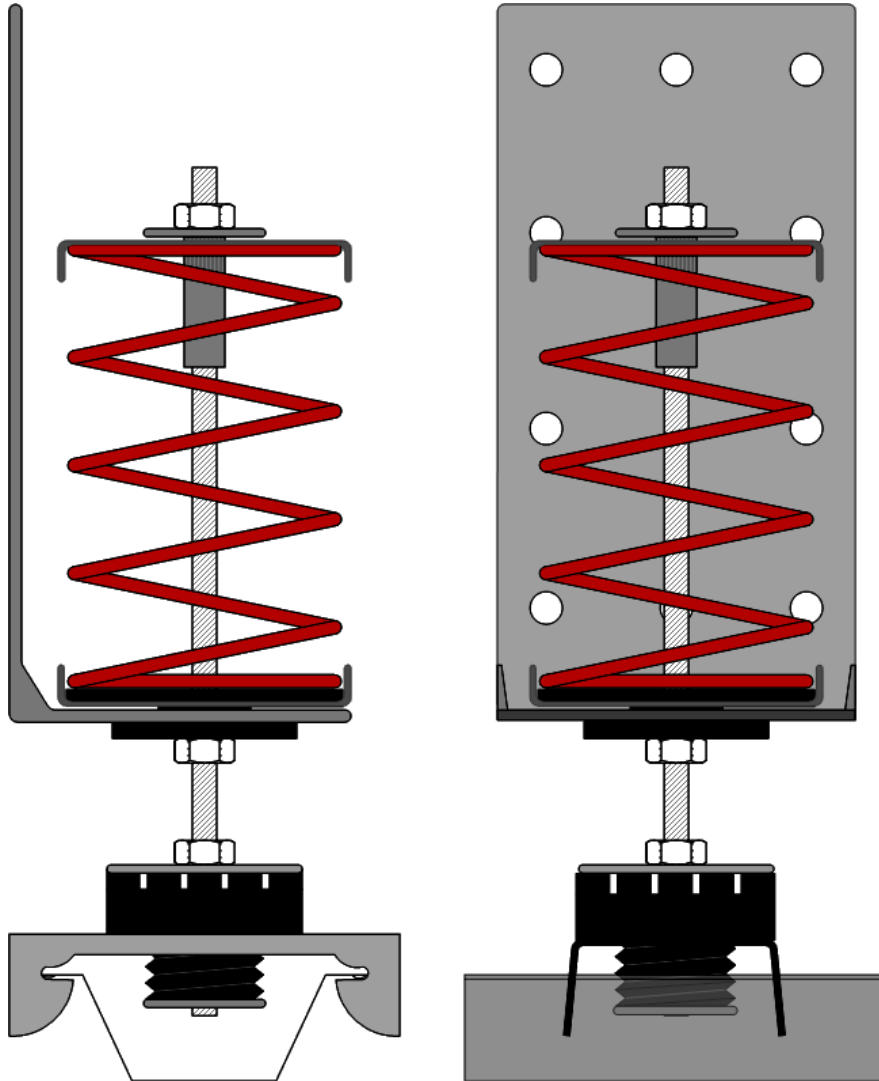

**SHIPPED FULLY  
ASSEMBLED  
AND CALIBRATED**

# RSIC-SI-1 ULTRA SOUND ISOLATION CLIP

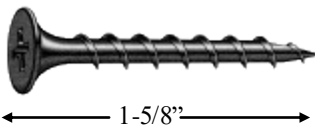
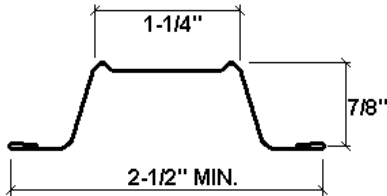

1-5/8"

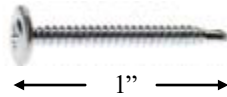

1"

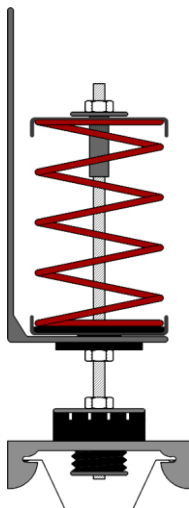

## Drywall Furring Channel:

- **Minimum Requirements:** 25 gauge, hemmed edge detail required on all 25 gauge furring channel. Meets or exceeds SSMA requirements.
- **Depth:** 7/8 inch
- **Width Bottom:** 2-1/2 inch wide minimum.
- **Width Top:** 1-1/4 inch wide

Splice drywall furring channel (hat track) with 6 inch overlap in mid span (between two clips) secure with 18 ga tie wire, or two 7/16" framing screws.

## Fasteners:

- **RSIC-SI-1 ULTRA Spring to Wood:** #8 x 1 inch minimum size coarse thread screw.
- **RSIC-SI-1 ULTRA Spring to Steel:** # 8 x 1/2 inch minimum size fine thread screw.
- DO NOT fasten Resilient Sound Isolation Clips (RSIC-SI-1 ULTRA Spring) to framing members with nails. Use only approved screws.

## Resilient Sound Isolation Clip (RSIC-SI-1 ULTRA Spring)

- **Maximum Spacing:** 48 inches on center
- **Design Load at 1/2" deflection from preset height**
- Red = 40 Lbs
- Green = 30 Lbs
- Blue = 20 Lbs
- White = 10 Lbs
- Yellow = 5 Lbs

## RSIC-SI-1 ULTRA Spring Dimensions:

- RSIC-SI-1 ULTRA Spring clip Installed height 8"
- RSIC-SI-1 ULTRA Spring clip 1-1/4" Deep
- RSIC-SI-1 ULTRA Spring clip 3" Wide

## Average Labor Rates:

- **RSIC-SI-1 ULTRA Spring:** 40 clips per man hour
  - **Drywall Furring Channel:** 550LF per man hour
- Labor rates provided to PAC International, Inc by an independent contracting firm.

PAC International, Inc. Tel: (866) 774-2100 Technical: (866) 649-2710 Web Site: [www.pac-intl.com](http://www.pac-intl.com)

PAC International, LLC. All Rights Reserved. • (866) 774-2100 • Fax (866) 649-2710

RSIC® is a registered Trade Mark of PAC International, LLC.

# RSIC-SI-1 ULTRA SOUND ISOLATION CLIP

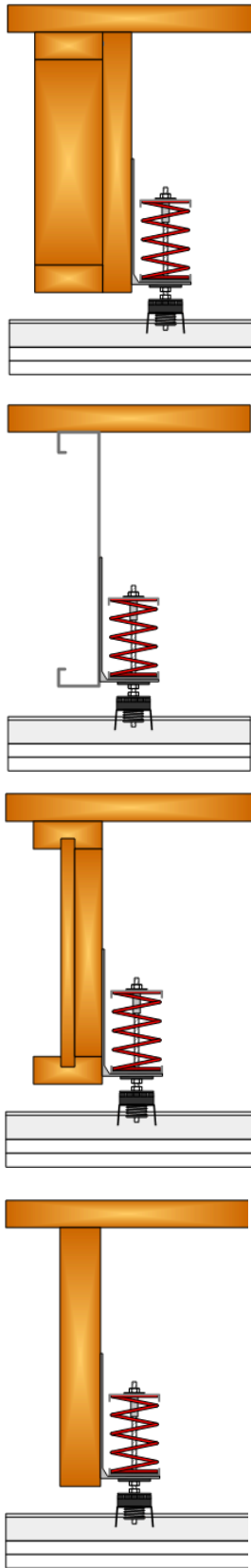

## Ceilings:

- Resilient Sound Isolation Clips (RSIC-SI-1 ULTRA Spring) maximum spacing 24" x 48" on center .
- Layout the RSIC-SI-1 ULTRA Spring clips according to general guidelines represented in this installation manual.
- Any additional or non standard room dimensions need to be addressed by a professional engineer.
- Carefully remove RSIC-SI-1 ULTRA Spring pre-assembled, and pre-calibrated clips from packaging.
- Be cautious to not rotate the RSIC-1 clips separate from the Upper bracket. This may change the factory calibration of RSIC-SI-1 ULTRA Spring .
- Verify the correct quantity of each RSIC-SI-1 ULTRA Spring isolator (weight / color) is included in the shipment.
- Layout the RSIC-SI-1 ULTRA Spring clips out on the floor (reflecting the ceiling above) Ensure there are no additional items required to complete the installation, IE: Additional blocking to support the RSIC-SI-1 ULTRA Spring clips, or additional clips to support the drywall furring channel.
- Red 40 Lb clips are for the field
- Blue 20 Lb clips are for the field, edge.
- White 10 Lb clips are for edge, corner, and or infill where additional support is needed
- Yellow 5 Lb clips for the edge, corner.
- Fasten the Resilient Sound Isolation Clip (RSIC-SI-1 ULTRA Spring) to the structure with fasteners approved for a minimum pull-out and shear of 100 lbs. Allowing for the predetermined 1/2" deflection after the gypsum board has been installed.
- Using a laser level, or tape measure set the height for all of the RSIC-SI-1 ULTRA Spring brackets at the same height
- Allow 1/2" deflection after all gypsum board has been installed.
- Ensure RSIC-SI-1 ULTRA Spring is securely fastened to the structure.
- At the perimeter, the distance between the wall and first support for the drywall shall be less than 8".
- Variances in the field may require additional adjustment to ensure a consistent system. (see field calibration guide)
- To field adjust the RSIC-SI-1 ULTRA Spring clip, rotate the RSIC-1 clip of the RSIC-SI-1 ULTRA clip clockwise to raise, or tighten the spring. In converse rotate the RSIC-1 clip of the RSIC-SI-1 ULTRA Spring clip counter clockwise to lower the RSIC-1 clip. Lowering the RSIC-1 clip will not loosen the spring. To adjust the spring itself you will need to hold the top Cup washer and turn the threaded rod from the top side.
- When attaching plywood or other hard surface materials to light gauge drywall furring channel use RSIC-Super Coarse screw

PAC International, Inc. Tel: (866) 774-2100 Technical: (866) 649-2710 Web Site: [www.pac-intl.com](http://www.pac-intl.com)

PAC International, LLC. All Rights Reserved. • (866) 774-2100 • Fax (866) 649-2710

RSIC® is a registered Trade Mark of PAC International, LLC.

# RSIC-SI-1 ULTRA SOUND ISOLATION CLIP

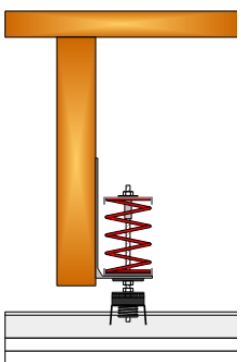
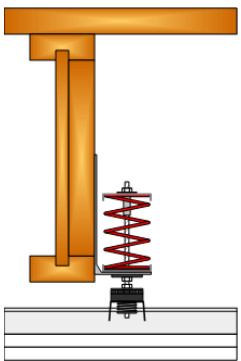
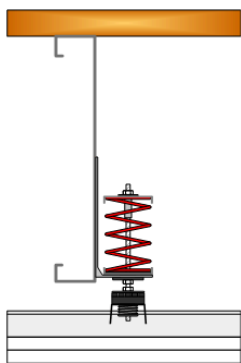
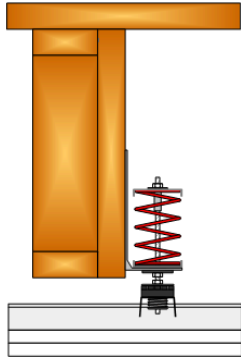

## Ceilings:

- Snap the drywall furring channel (hat track) into the RSIC-1 section of the RSIC-SI-1 ULTRA Spring clips.
- Add strong back consisting of 2 pieces of drywall furring channel, on the top side of the standard drywall furring channel to assist in leveling the ceiling at or near the perimeter. The strong back shall be placed perpendicular to the main drywall furring channels
- Install the gypsum board to the drywall furring channel leaving a 1/8" to 1/4" gap around the perimeter of the entire ceiling.
- Caulk around the entire perimeter of the ceiling wall intersection.
- Use fire and smoke rated acoustical sealant where required.

## Calibration and Adjustment:

- To field adjust the RSIC-SI-1 ULTRA HOME SERIES clip, rotate the RSIC-1 clip of the RSIC-SI-1 ULTRA HOME SERIES clip clockwise to raise. In converse rotate the RSIC-1 clip of the RSIC-SI-1 ULTRA HOME SERIES clip counter clockwise to lower. Lowering the RSIC-1 clip will not loosen the spring. To adjust the spring itself you will need to hold the top Cup washer and turn the threaded rod from the top side.
- The Pre-Calibration of the RSIC-SI-1 ULTRA HOME SERIES clip is designed to deflect 1/2" from its pre-loaded (pre-set) position after all layers of gypsum board has been installed.

## General Information:

- Resilient Sound Isolation Clip Spring Isolator (RSIC-SI-1 ULTRA Spring), furring channel (hat track) and gypsum board shall not carry heavy loads such as Projectors, HVAC Ducting, Curtains, etc.
- Splice furring channel (hat track) with 6 inch overlap in mid span, secure with 18 ga. tie wire or with two framing screws (7/16")
- Seal all potential air leaks with non-hardening acoustical caulking to achieve best noise control results. Use fire rated sealant where required.
- When attaching the RSIC-SI-1 ULTRA Spring clips to a steel Joist the minimum allowable thickness is 20 ga. (0.030).
- When attaching plywood or other hard surface materials to 25 Gauge drywall furring channel use RSIC-Super Coarse screw

## Fire Test Information:

[WWW.PAC-INTL.COM](http://WWW.PAC-INTL.COM)

Check UL Fire Resistance Directory File # R16638

Check UL's web pages. [www.ul.com/database](http://www.ul.com/database)

Contact UL (877) UL-HELPS

PAC International, Inc. Tel: (866) 774-2100 Technical: (866) 649-2710 Web Site: [www.pac-intl.com](http://www.pac-intl.com)

PAC International, LLC. All Rights Reserved. • (866) 774-2100 • Fax (866) 649-2710

RSIC® is a registered Trade Mark of PAC International, LLC.

# RSIC-SI-1 ULTRA SOUND ISOLATION CLIP

## APPLICATION RECOMMENDATIONS FOR CEILINGS WOOD OR STEEL FRAMING

### RSIC-SI-1 ULTRA Spring INSTALLATION WITH FRAMING SPACED @ 24" OC. & RSIC-SI-1 ULTRA @ 24" OC.

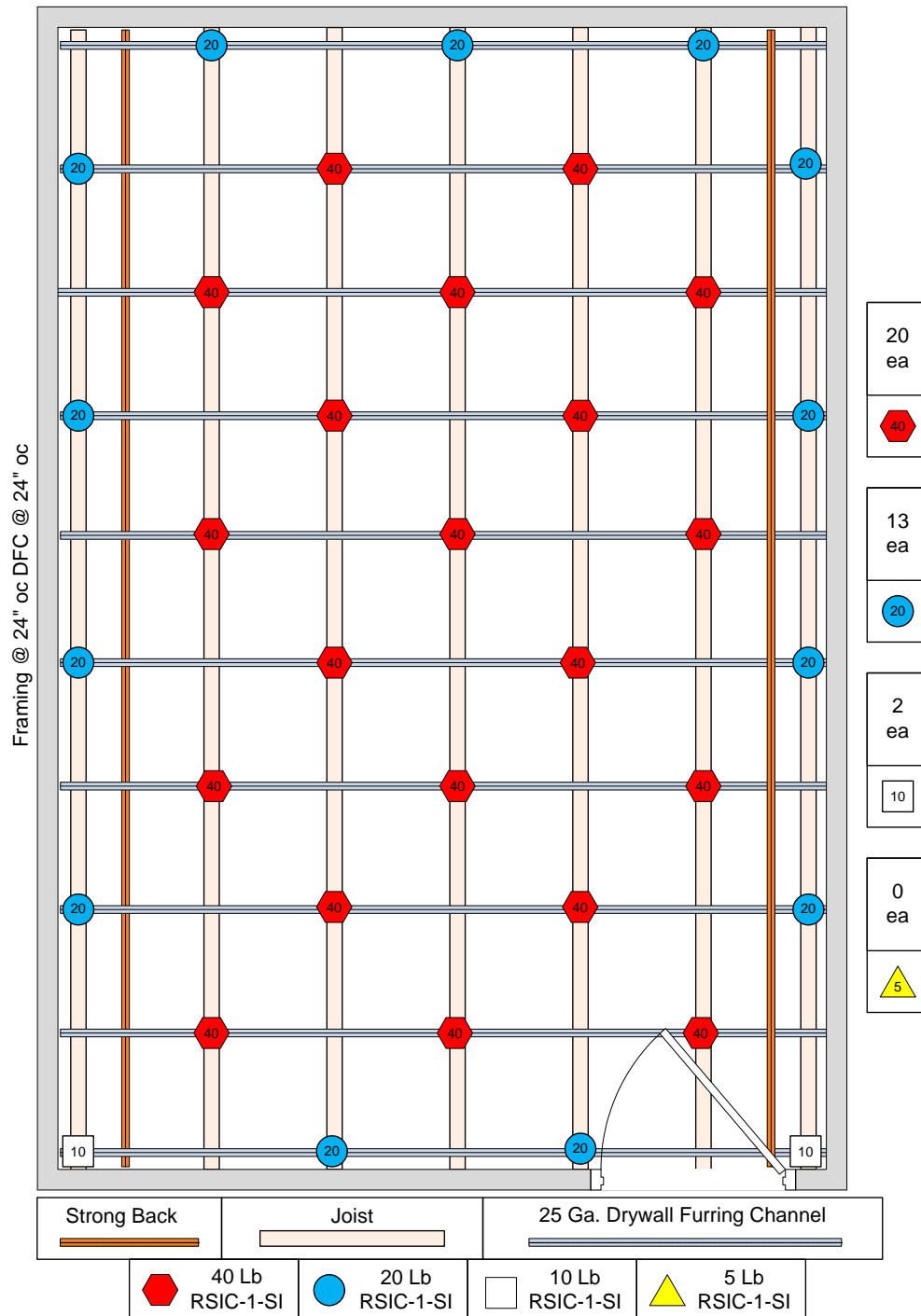

PAC International, Inc. Tel: (866) 774-2100 Technical: (866) 649-2710 Web Site: [www.pac-intl.com](http://www.pac-intl.com)

PAC International, LLC. All Rights Reserved. • (866) 774-2100 • Fax (866) 649-2710  
RSIC® is a registered Trade Mark of PAC International, LLC.

# RSIC-SI-1 ULTRA SOUND ISOLATION CLIP

## APPLICATION RECOMMENDATIONS FOR CEILINGS WOOD OR STEEL FRAMING

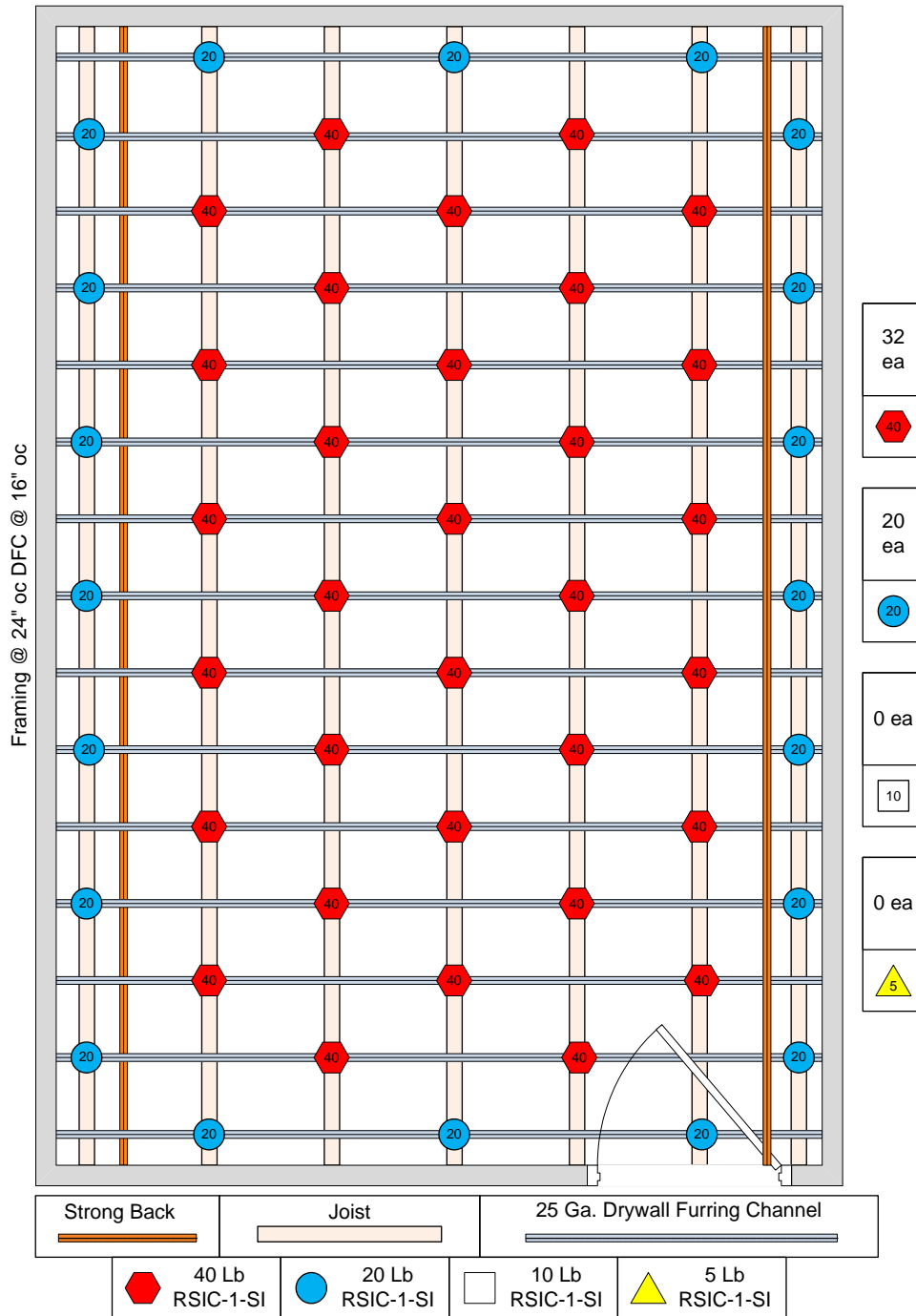

PAC International, Inc. Tel: (866) 774-2100 Technical: (866) 649-2710 Web Site: [www.pac-intl.com](http://www.pac-intl.com)

PAC International, LLC. All Rights Reserved. • (866) 774-2100 • Fax (866) 649-2710  
RSIC® is a registered Trade Mark of PAC International, LLC.

# RSIC-SI-1 ULTRA SOUND ISOLATION CLIP

## APPLICATION RECOMMENDATIONS FOR CEILING, WOOD OR STEEL FRAMING

### RSIC-SI-1 ULTRA Spring INSTALLATION WITH FRAMING SPACED @ 16" OC. & RSIC-SI-1 ULTRA @ 24" OC.

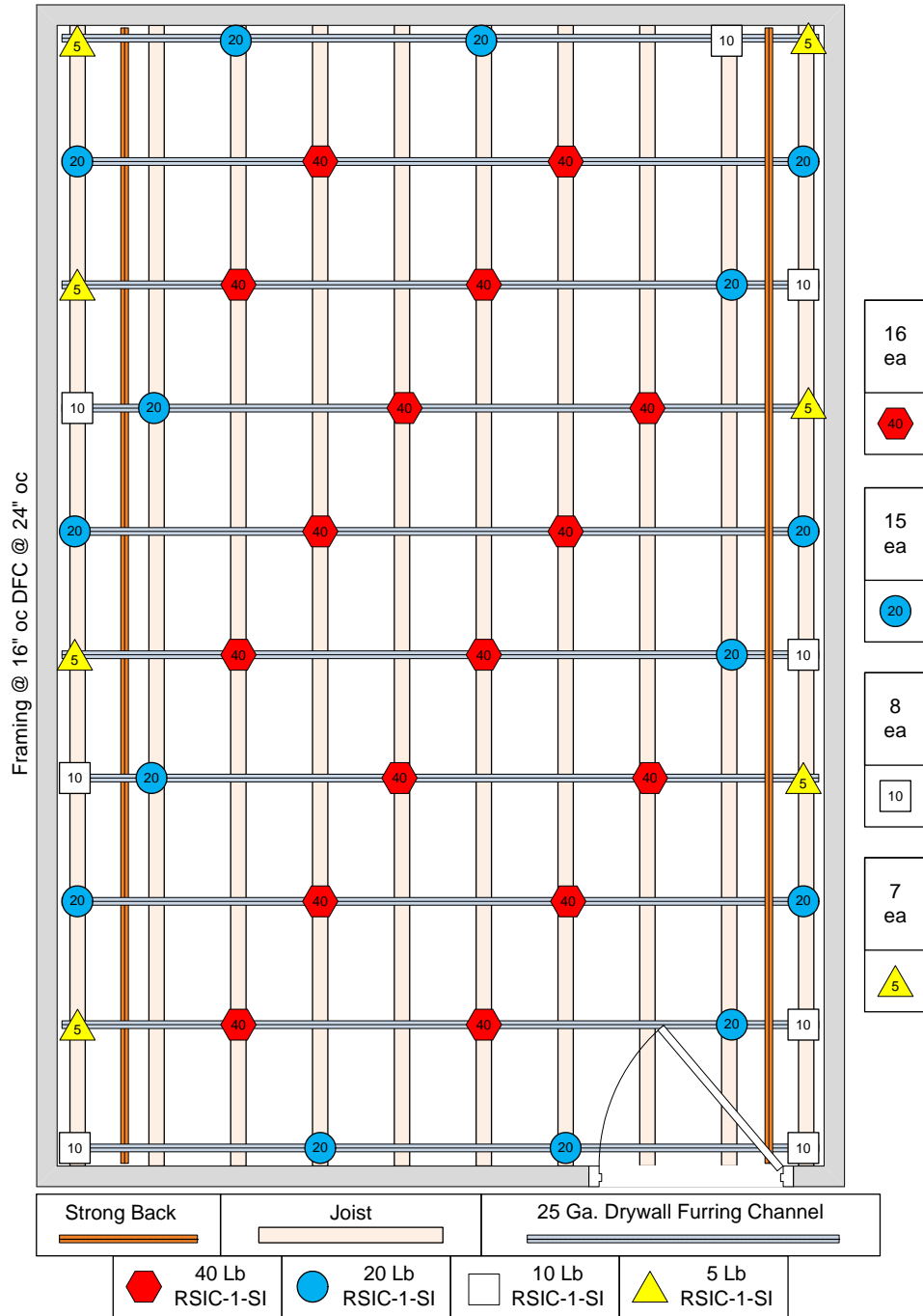

PAC International, Inc. Tel: (866) 774-2100 Technical: (866) 649-2710 Web Site: [www.pac-intl.com](http://www.pac-intl.com)

PAC International, LLC. All Rights Reserved. • (866) 774-2100 • Fax (866) 649-2710  
RSIC® is a registered Trade Mark of PAC International, LLC.

# RSIC-SI-1 ULTRA SOUND ISOLATION CLIP

## APPLICATION RECOMMENDATIONS FOR CEILING, WOOD OR STEEL FRAMING

### RSIC-SI-1 ULTRA Spring INSTALLATION WITH FRAMING SPACED @ 16" OC. & RSIC-SI-1 ULTRA @ 16" OC.

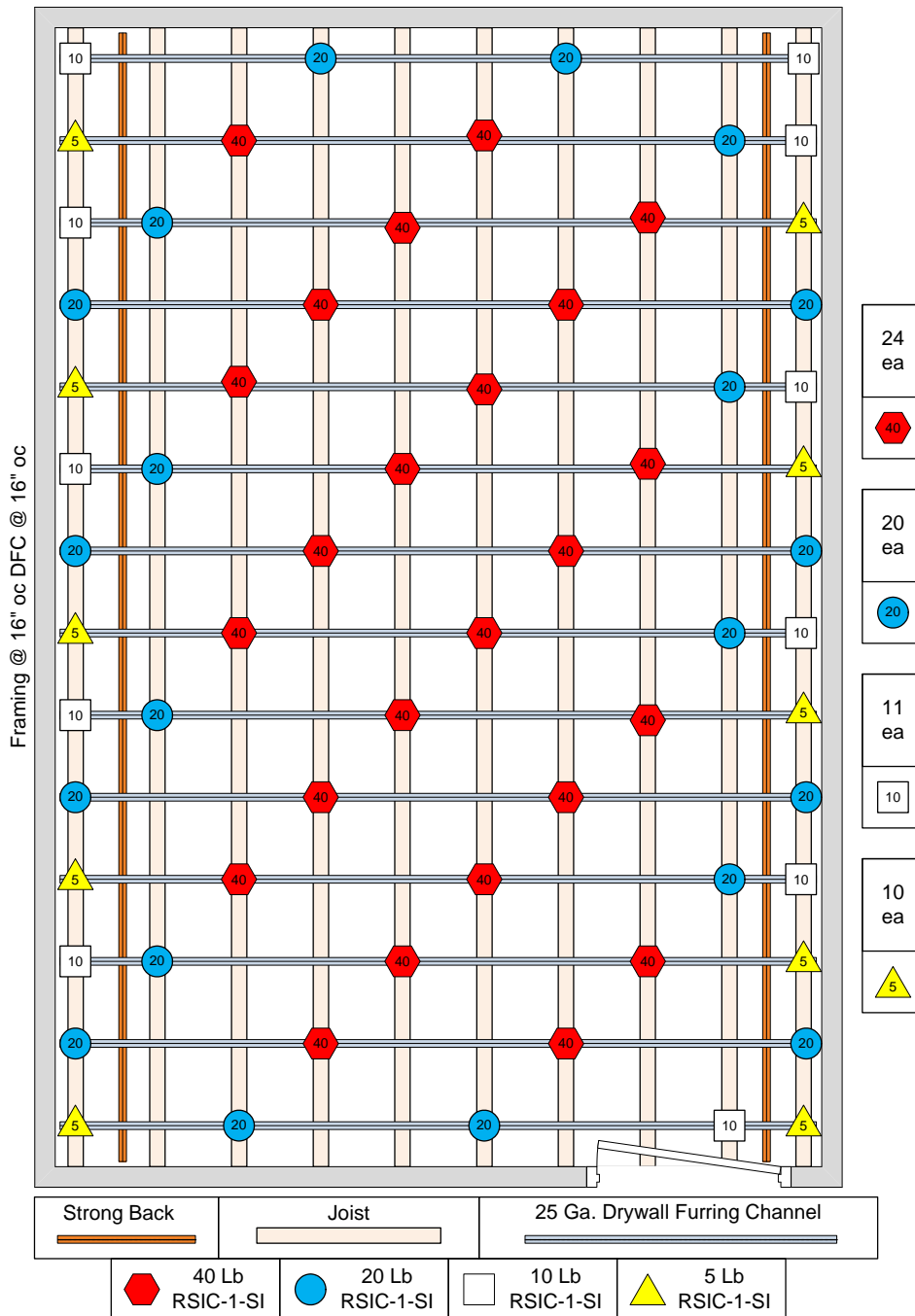

PAC International, Inc. Tel: (866) 774-2100 Technical: (866) 649-2710 Web Site: [www.pac-intl.com](http://www.pac-intl.com)

PAC International, LLC. All Rights Reserved. • (866) 774-2100 • Fax (866) 649-2710  
RSIC® is a registered Trade Mark of PAC International, LLC.



# RSIC-SI-1 ULTRA SOUND ISOLATION CLIP

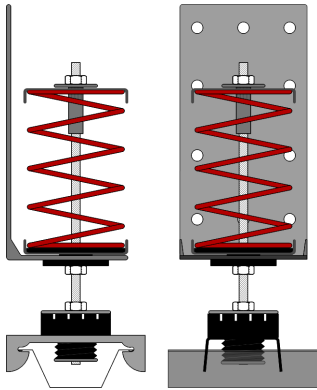

## Members of the International Code Council

### WARRANTY DISCLAIMER AND LIABILITY LIMITATION LANGUAGE

#### **NO EXPRESS OR IMPLIED WARRANTIES**

THERE IS NO WARRANTY, REPRESENTATION OR CONDITION OF ANY KIND; AND ANY WARRANTY, EXPRESS OR IMPLIED, IS EXCLUDED AND DISCLAIMED, INCLUDING THE IMPLIED WARRANTIES OF MERCHANTABILITY AND OF FITNESS FOR A PARTICULAR PURPOSE. Some states do not allow limitations on implied warranties, so the above limitation may not apply to you.

#### **LIABILITY LIMITED TO RETURN OF PURCHASE PRICE**

IT IS AGREED THAT SELLER'S LIABILITY AND PURCHASER'S SOLE REMEDY, WHETHER IN CONTRACT, UNDER ANY WARRANTY, IN TORT (INCLUDING NEGLIGENCE), IN STRICT LIABILITY OR OTHERWISE, SHALL NOT EXCEED THE RETURN OF THE AMOUNT OF THE PURCHASE PRICE PAID BY PURCHASER, AND UNDER NO CIRCUMSTANCES SHALL SELLER BE LIABLE FOR ANY SPECIAL, INCIDENTAL OR CONSEQUENTIAL DAMAGES, INCLUDING, BUT NOT LIMITED TO, PERSONAL INJURY, PROPERTY DAMAGE, DAMAGE TO OR LOSS OF EQUIPMENT, LOST PROFITS OR REVENUE, COSTS OF RENTING REPLACEMENTS AND OTHER ADDITIONAL EXPENSES, EVEN IF SELLER HAS BEEN ADVISED OF THE POSSIBILITY OF SUCH DAMAGES. THE PRICE STATED FOR THE EQUIPMENT IS A CONSIDERATION IN LIMITING SELLER'S LIABILITY AND PURCHASER'S REMEDY. Some states do not allow the exclusion or limitation of incidental or consequential damages, so the above limitation or exclusion may not apply to you.

#### **SELLER NOT LIABLE FOR PURCHASER'S NEGLIGENCE**

SELLER WILL NOT BE LIABLE FOR ANY DAMAGES, LOSSES OR EXPENSES AS A RESULT OF PURCHASER'S NEGLIGENCE, WHETHER DEEMED ACTIVE OR PASSIVE AND WHETHER OR NOT ANY SUCH NEGLIGENCE IS THE SOLE CAUSE OF ANY SUCH DAMAGE, LOSS OR EXPENSE.

#### **MODEL FOR DEMONSTRATION PURPOSES ONLY**

THE MODEL OR SAMPLE SHOWN BY SELLER TO BUYER IS USED FOR DEMONSTRATION PURPOSES ONLY. THERE IS NO WARRANTY THAT THE GOODS AS DELIVERED SHALL CONFORM TO THE MODEL OR SAMPLE, AND CONFORMITY OF THE GOODS TO THE MODEL OR SAMPLE IS NOT PART OF THE BASIS OF THE BARGAIN BETWEEN SELLER AND BUYER.

#### **NO WARRANTY OR COMPLIANCE WITH SAFETY CODE OR REGULATION**

SELLER DOES NOT WARRANT THAT ANY OF THE GOODS SOLD WILL MEET OR COMPLY WITH THE REQUIREMENTS OF ANY SAFETY CODE, BUILDING OR DWELLING CODE, OR REGULATION OF ANY STATE, MUNICIPALITY OR OTHER JURISDICTION.

#### **NEVADA LAW APPLIES**

SELLER AND BUYER AGREE THAT ALL ASPECTS OF THIS TRANSACTION INCLUDING THE APPLICABLE STATUTE OF LIMITATIONS SHALL BE GOVERNED BY THE INTERNAL LAW OF THE STATE OF NEVADA, AND NOT THE LAWS OF CONFLICTS.

This warranty gives you specific legal rights, and you may also have other rights which vary from state to state.

**PAC International, Inc. Tel: (866) 774-2100 Technical: (866) 649-2710 Web Site: [www.pac-intl.com](http://www.pac-intl.com)**

PAC International, LLC. All Rights Reserved. • (866) 774-2100 • Fax (866) 649-2710

RSIC® is a registered Trade Mark of PAC International, LLC.